



VERSAPRINT 2

The next generation



GLOBAL. AHEAD. SUSTAINABLE.



ersa VERSAPRINT® 2 ELITE plus

The sturdy basic version uses an area camera to align the substrate to the stencil and can use this to carry out optional inspection tasks. The stencil support can be adjusted without tools for frame sizes from 450 mm to 740 mm. The ELITE plus can be upgraded or retrofitted with all the options available for the VERSAPRINT 2 series, including 2D- and 3D-camera.



ersa VERSAPRINT® 2 PRO²

With its fast 2D-LIST camera (LIST = Line Scan Technology), this system is particularly suitable for products with a high inspection requirement. It can also be upgraded or retrofitted with all the options of the VERSAPRINT 2 series.



ersa VERSAPRINT® 2 ULTRA³

For operators who pay special attention to the small print. The Ultra³ model uses the very latest measuring technology provided by the 3D-LIST camera. The shape of the smallest solder paste depots plays a major role in the printed volume and ultimately for the shape of the solder connection. Is the height of the paste depot consistent or does it drop towards the edges? The Ultra³ can answer this question for you. It is both a stencil printer and 3D-SPI (Solder Paste Inspection) in one. It can also be upgraded or retrofitted with all the options of the VERSA-PRINT 2 series.

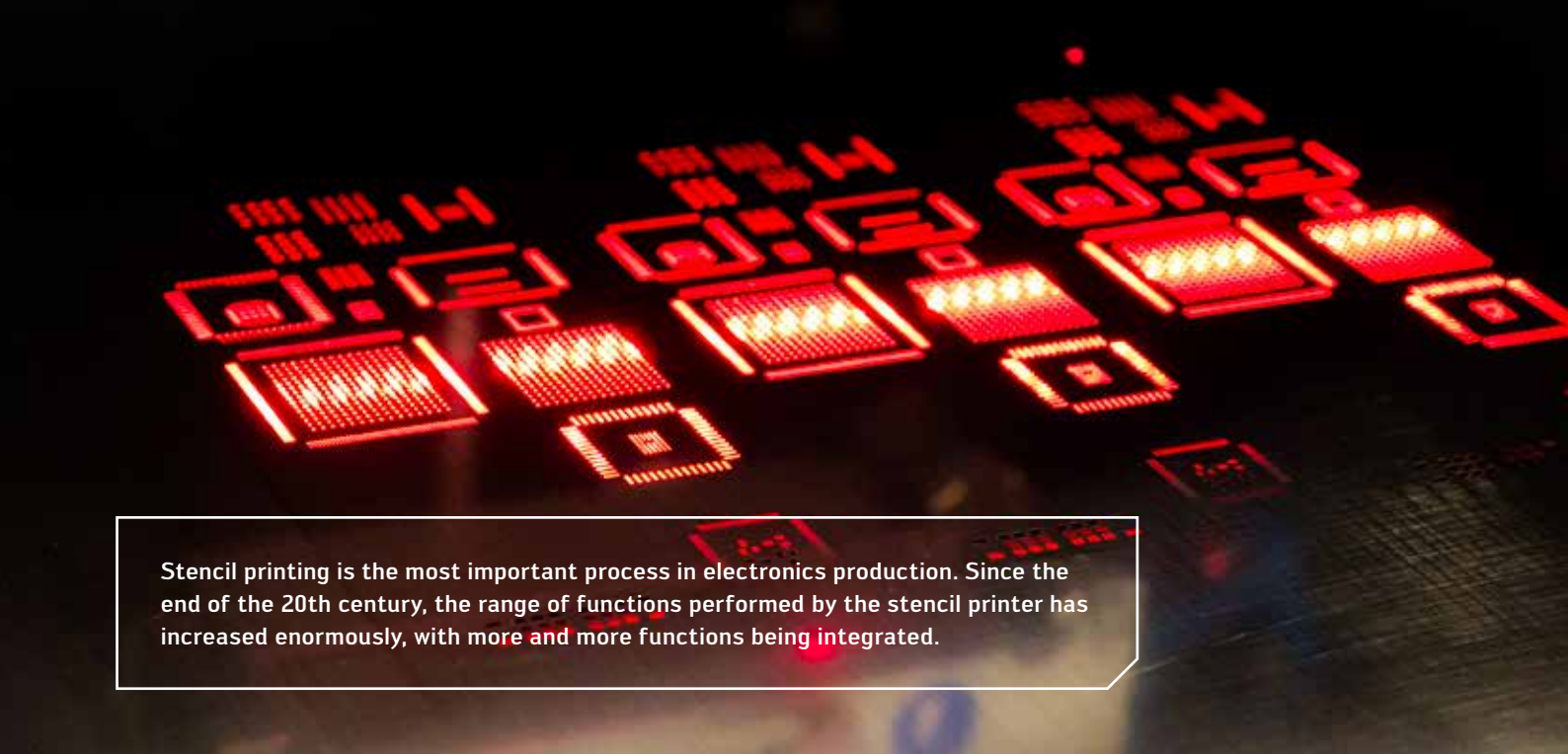

Stencil printing is the most important process in electronics production. Since the end of the 20th century, the range of functions performed by the stencil printer has increased enormously, with more and more functions being integrated.

VERSAPRINT 2

Unique printer platform with fully integrated inspection – partial, 100 % 2D or 100 % 3D

Currently, the VERSAPRINT series not only handles the automatic cleaning of the underside of the stencil and inspection of the printing result, with a choice of 2D or 3D inspection, it also carries out further functions and processes along the production line. The simple printer has long become a multi-functional system. These days, every efficiency-oriented manufacturer inspects the printing result before the assembly is

mounted. The optional three-dimensional inspection of the VERSAPRINT series reliably detects deviations in volume of the solder paste depot.

Dispensing systems in the printer permit additional adhesive or solder paste spots to be set after solder paste printing. This means components can be additionally fixed or solder spots can be provided with additional solder volume.

The set-up check during printer set-up guarantees that the right materials and tools are used for the correct execution of orders.

The data recording functions collect the process data for the solder paste printing, the materials used and document the current manufacturing quality.

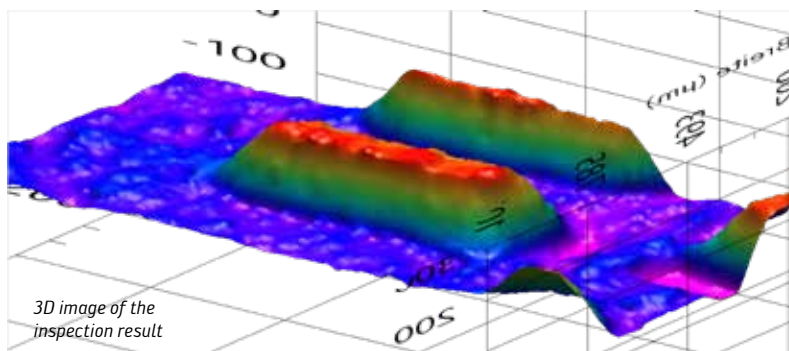



VERSAPRINT 2 PRO²

**The first stencil printer worldwide
with fully integrated 100 % SPI**

Almost 70 % of all process errors in the SMT line can be traced back to the stencil print. Furthermore, most of the errors in solder paste printing can be eliminated at low cost provided they are detected in good time. For this reason, the printing result is inspected in most electronic products before the components are placed on the PCB.

The familiar 2D inspection method of SPI is ideal for most applications and stands

out on account of its simple programming and parameter finding. The percentage specification of minimum cover by the print makes it easier to specify process limits. Adequate default values cover the usual process limits.

Ersa is the only manufacturer on the market able to achieve a 100% printing check at line speed thanks to 2D inspection integrated in the printer.

The revolutionary camera using Line Scan Technology (LIST) is at the heart of the integrated inspection feature. It can inspect the printing result at a speed of 200 mm/s over the whole scanning width.

With the VERSAPRINT 2 PRO², inspection takes place directly following the printing process.

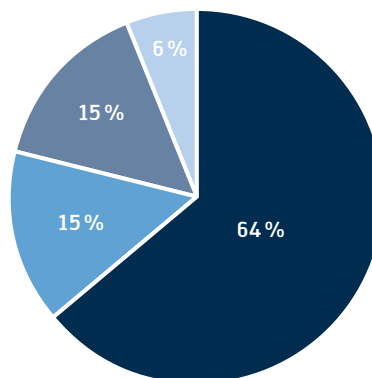

- Paste print
- Reflow
- Pick & Place
- Other

Error distribution in SMD process – C. H. Mangin

VERSAPRINT 2 ELITE plus

Unique advantages

- True parallel process for print and inspection
- LIST camera for 100 % Inspection at line speed
- Little floor space required for print and inspection
- Closed-loop process control for print and SPI
- Easy programming and handling
- Printer and SPI in one

The VERSAPRINT 2 ELITE plus is the ideal printer to enter line production if 100% inspection is not required - for example if an SPI system already exists in the production line. It is the ideal printer for customers expecting a perfect print result in combination with an easy to use printing system.

The printer is equipped with an area camera that uses two separate camera modules. Different types of illumination make it possible to detect even the most complicated structures on the substrate.

If the VERSAPRINT 2 ELITE plus is combined with an SPI System, the closed-loop function sends feedback to the printer and optimizes the printing process.

The VERSAPRINT 2 ELITE plus can be equipped with the optionally available 2D inspection which allows to verify coverage, shorts and offset in glue or solder paste printing. On the stencil the apertures and under stencil smearing will be inspected. The system can be retrofitted with 2D or 3D-SPI.

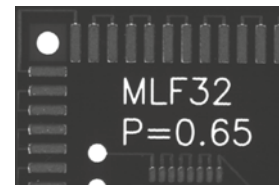

▲ Direct light source

▼ Diffuse light source



Schematic of the LIST camera

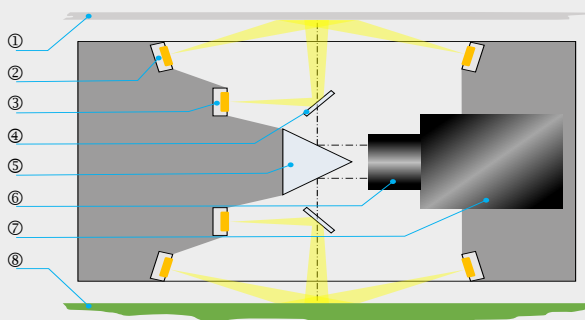

- | | |
|---------------------------|---------------|
| ① stencil | ⑤ prism |
| ② diffused lighting | ⑥ lens |
| ③ axial illumination | ⑦ LIST camera |
| ④ semi-transparent mirror | ⑧ substrate |





VERSAPRINT 2 ULTRA³

**The first stencil printer worldwide
with fully integrated 100% 3D SPI**

Advantages vs. 3D SPI stand-alone systems:

- 3D-SPI for the inspection of complex PCBs direct after the printing process
- VERSAPRINT stencil inspection detects errors before they appear
- Zero reference measurement of the unprinted PCB can be done before every print
- Integrated closed-loop function for print offset compensation
- One software platform for print and inspection – one consistent operator concept
- Maintenance and service for only one machine
- One contact for both processes
- Less space required on the shop floor

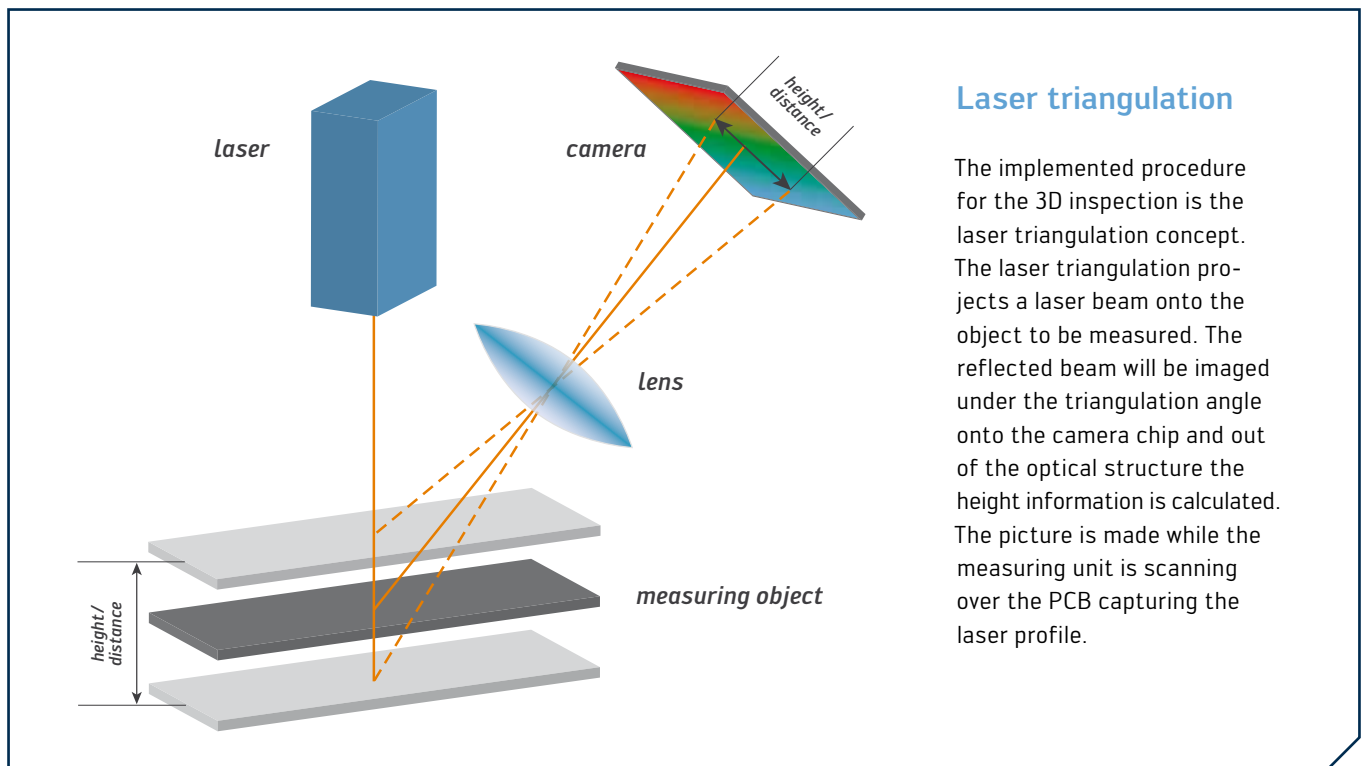

Laser triangulation

The implemented procedure for the 3D inspection is the laser triangulation concept. The laser triangulation projects a laser beam onto the object to be measured. The reflected beam will be imaged under the triangulation angle onto the camera chip and out of the optical structure the height information is calculated. The picture is made while the measuring unit is scanning over the PCB capturing the laser profile.

Inspection: Requirements

The following properties of the solder paste print are evaluated during 3D inspection:

- Volume
- Area
- Height
- Shorts
- Offset

If the system determines deviations in the solder paste printing to the specifications for the above-mentioned properties, a 2D image of the area affected

is recorded for better representation and analysis through the operator. In addition, the operator can turn and zoom in on the 3D image of the error detected as required in order to carry out reliable analysis efficiently. The height profiles are shown color-coded. Limit areas are highlighted in yellow and red.

Stencil inspection is retained as a feature of 2D inspection. It triggers auto-

matic stencil cleaning if solder paste soiling on the underside or blockage of a stencil opening should have exceeded the set limit.

A further advantage of the integrated inspection is the closed-loop function for print offset correction. It is able to detect offsets and correct them automatically in line with the direction of printing.

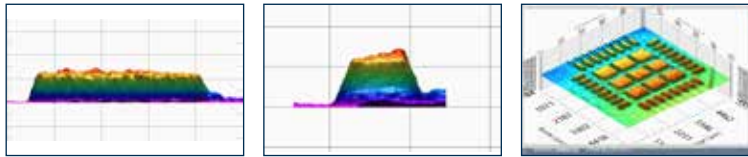

f.l.t.r.: Profile of the inspection result incl. height indication, Profile of the inspection result incl. height indication – rotated by 90°, Inspection result

Inspection: Determination of zero point

The critical point for height measurement is the definition of the zero point. When the measurement is carried out, the pad area which represents the zero position is covered with solder paste. For this reason, current SPI systems usually measure a limited number of non-printed circuit boards before production as a reference for determining the zero point.

With this method, the height of the non-printed pads is set in relation to its environment (stop mask, via-filling, placement pressure etc.), on which the zero height has to be determined during production. These values are then used to form average values which are used for measurement during production.

This usually has to be repeated in the case of batch or supplier change. This is the major advantage of integrated inspection in the printer: every printed circuit board can be measured before printing. In the event of very demanding requirements in terms of precision of the result or where there are reserves in terms of cycle time, the system can always carry out a preliminary inspection.

SPC data analysis

Statistic Process Control, or SPC for short, is an important tool for the continual improvement of the production process. The SPC integrated in VERSAPRINT 2 collects all the process data relevant for you including the inspection results, delivers a compact summary of the data and also indicates trends.

The data make it possible to compare several batches or production shifts, and thus enable the detailed qualification of processes or individual components such as the stencil or the paste. Inspection results can be saved as a fault pattern together with the data: equally fault-free printed circuit boards can be completely documented. This means later qualifica-

tion and analysis of the results is always possible. The SPC data analysis can be used at the machine for immediate optimization of the current process, at the end of the line as comparison with the AOI system (Automatic Optical Inspection) or as a control tool for production management.

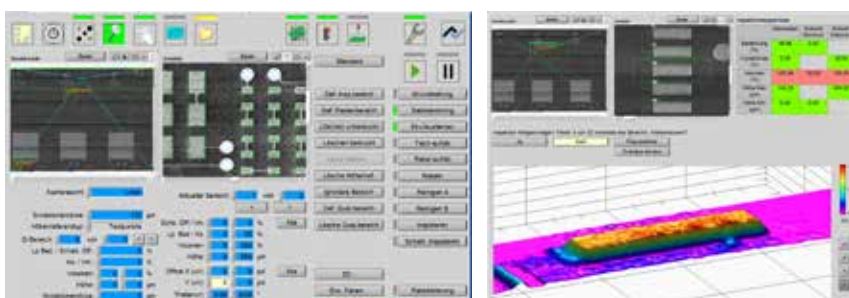

testing points for height reference measurement

inspection result – graphic visualization of measurements with set and actual values.

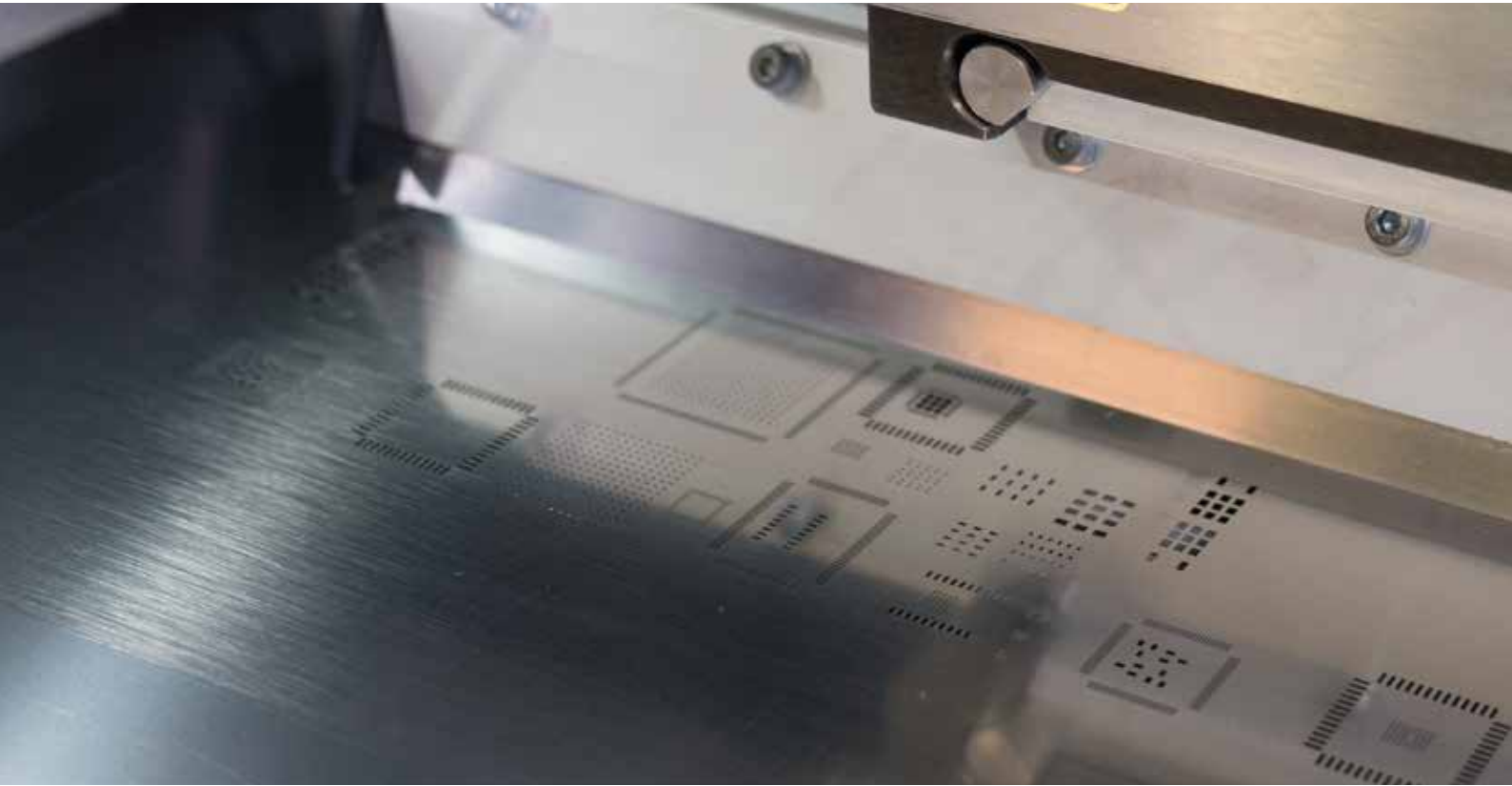

Standard Features for ELITE plus, PRO² & ULTRA³



Substrate handling and parallel process

- Substrate is clamped between over top clamping and transport belt
- Thin substrates are clamped without warping
- Precise pressure adjustment for side clamping using the track width motor prevents warping of even very thin boards
- Minimum snap off and overlap of the substrate edge



Print head and squeegee

- Closed pressure system for repeatable print result
- Optional weight compensation of squeegee and print head enables even very small pressure
- Easy mounting and pneumatic clamping of the squeegee
- Screen print head available as an option
- All common squeegees types can be used
- Squeegee angle is mechanically fixed to minimize operator influence

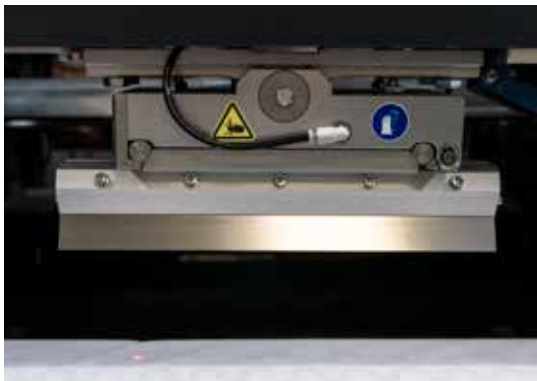

Stencil cleaner

- Cleaning system with wet, dry and vacuum cleaning mode
- Under stencil cleaning system with speed controlled paper feed for repeatable cleaning cycles
- Dispenser for exact and precise amount of cleaning solvent
- Intelligent stencil cleaner – a cleaning cycle will be automatically performed after a bad stencil inspection
- An easy concept of the cleaning unit enables a fast change over of the cleaning paper without the need of extra tools



Stencil mount and fitting

- Common stencil formats and quick-action clamping systems can be used directly.
- The stencil mount is fixed, alignment is carried out via the printing table – important for 3D stencil applications with extreme step
- Flexible mount for different stencil formats
- Programmable mechanical stop at the squeegee head for simple stencil mounting

Dispenser – auger screw or jet

- Screw dispenser for SMD glue or solder paste
- Dispensing of additional paste, e.g. for components with a higher demand of paste
- Glue dispensing to fix heavy or position critical components
- Jet dispenser for more flexibility and speed
- Optional heating unit available for temperature critical material
- Inspection of dispensed dots if 2D or 3D inspection is available



Options for ELITE plus, PRO² & ULTRA³



Retractable over-top clamping

- Perfect solution to print to the edge of the board
- No snap off between stencil and board
- Precise pressure adjustment for side clamping using the track width motor prevents warping of very thin boards
- Height fixation of the side clamping guarantees stencil support outside the print area

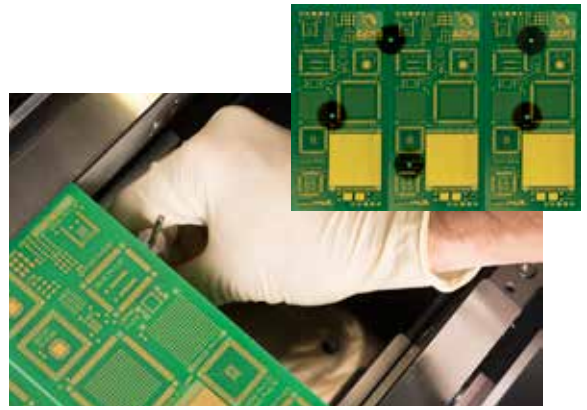
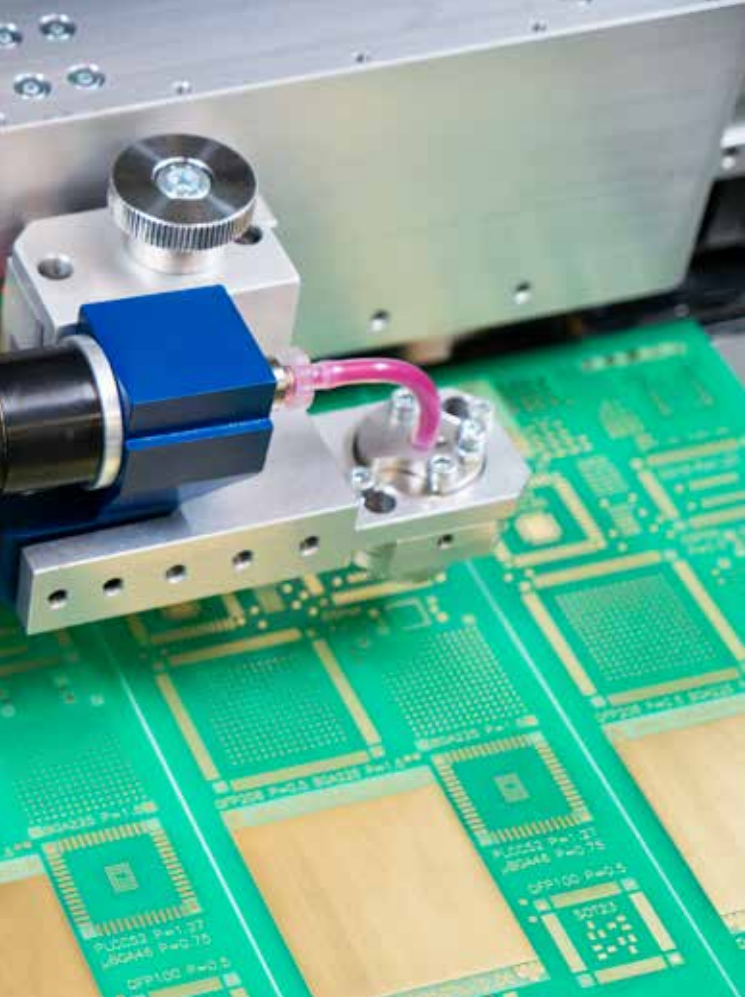

Camera-guided pin positioning

- Camera-guided positioning of the PCB support pins
- Ideal for assemblies where support is not possible on the components
- Prevents the pins being placed under the opening with "pin-in-paste" applications
- The positions of the pins can simply be marked on the printed circuit board at the monitor, and serve the set-up technician as a positioning aid – whether the pins have been placed completely and correctly can be seen at a glance

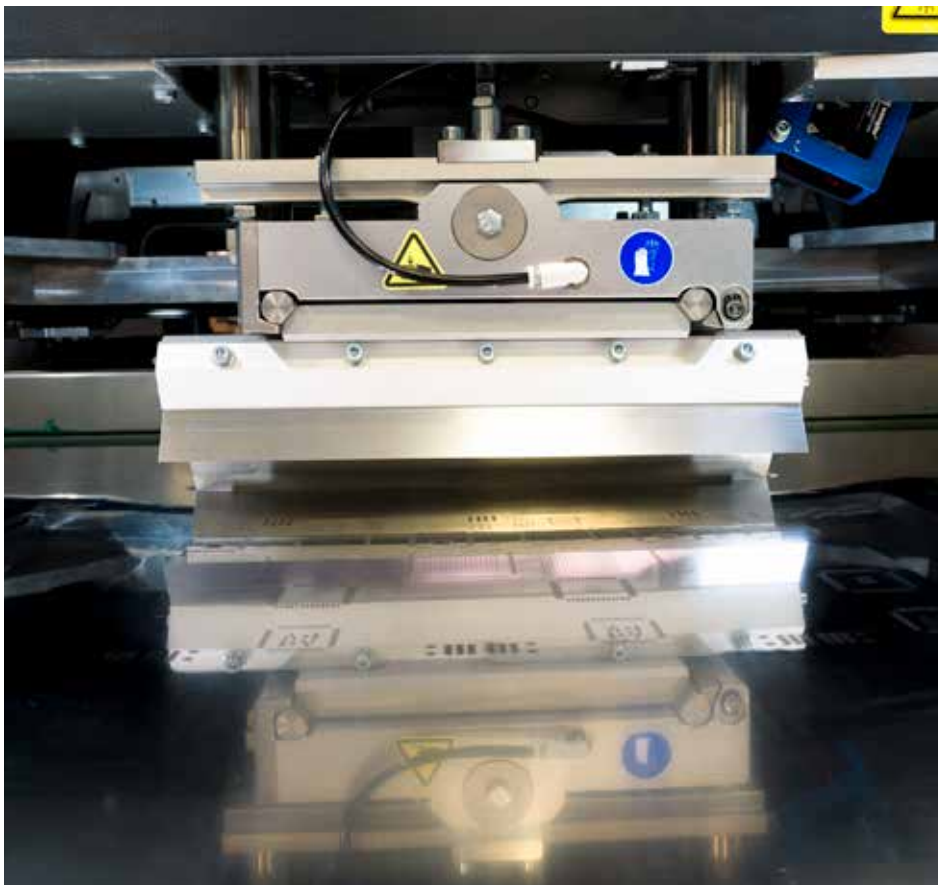

Additional options

- Paste height control
- Dispenser for print media
- Temperature and humidity sensor
- Climate control inside the printer
- Setup control and DMC
- Closed loop to SPI
- Flexible substrate support systems

Technical data VERSAPRINT 2

VERSAPRINT 2	ELITE plus	PRO ²	ULTRA ³
Substrate handling			
Maximum substrate size	550 mm x 500 mm		
Maximum printing size	680 mm x 500 mm with workholder possible		
Minimum substrate size	50 mm x 50 mm		
Substrate thickness	(0.2*) 0.5 ... 6 mm; 0.8 ... 6 mm with retractable clamping		
Maximum substrate weight	1 kg		
Component clearance	35 mm		
Transport clearance	3 mm		
Transport height	820 ... 975 mm		
Print parameters			
Print speed	5 ... 200 mm/s		
Print force	0 ... 260 N		
Separation speed	0.1 ... 50 mm/s		
Print mode	alternating, multiple print, flood/print		
Paste knead	programmable		
Stencil mounting			
Maximum stencil size	737 mm x 737 mm x 40 mm		
Minimum stencil size	450 mm x 450 mm x 25 mm		
Adjustable without tools	yes		
Performance			
Repeatability	± 12,5 µm @ 6 Sigma (CPR > 2)		
Print accuracy	± 25 µm @ 6 Sigma (CPR > 2)		
Cycle time	10 s + print	14 s + print	
Vision			
Fiducial size	0.5 ... 3 mm		
Fiducial types	all synthetic fiducials or any unique shape		
Camera	area camera	2D LIST camera	3D LIST camera
Field of view	10.4 mm x 8.3 mm	36.9 mm x 0.018 mm	34.8 mm x 0.017 mm
Inspection speed	1 picture/s	210 mm/s	130 mm/s
Resolution	8 µm/pixel	18 µm/pixel	17 µm/pixel; Z: 1 µm
Dimensions			
Width x depth x height	1,225 mm x 1,855 mm x 1,617 mm		
Weight max.	860 kg		
Electrical data/compressed air			
Power supply	5-wire system, 3x 400 V, N, PE 50/60 Hz, 16 A		
Air supply	6 ... 10 bar, 5 l/min; in vacuum cleaning mode 5.5 l/s		

*depending on substrate

Worldwide presence:

America:
usa@kurtzrsa.com

Asia:
asia@kurtzrsa.com

Vietnam:
info-kev@kurtzrsa.com

France:
kefrance@kurtzrsa.com

Mexico:
info-kmx@kurtzrsa.com

China:
info-esh@kurtzrsa.com

India:
india@kurtzrsa.com